

OVERVIEW

SM8142A

The SM8142A has independent coil drive oscillator circuit (OCL) and EL drive oscillator circuit (OCE) built-in. Accordingly, the frequency of oscillation can be individually changed to control the brightness, current consumption, and frequency over a wide range. However, there is no EL ON/OFF control pin. Instead, the EL ON/OFF function is achieved by switching the IC supply.

SM8142B

The SM8142B has an EL ON/OFF control pin, ENA (ON when HIGH, and OFF when LOW). However, the coil drive and EL output frequencies are derived from a single built-in oscillator (OSC), and therefore the frequencies cannot be changed independently of one another.

DESCRIPTION

The SM8142 comprises an oscillator, booster, and high voltage switching circuit functional blocks.

Block Diagram

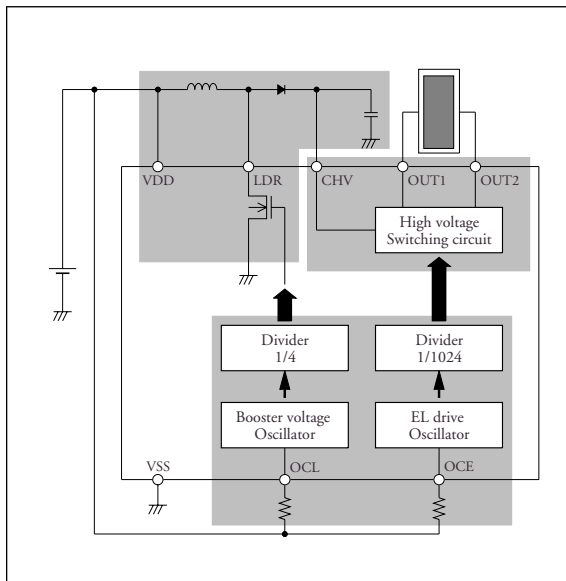

Figure 1. SM8142A

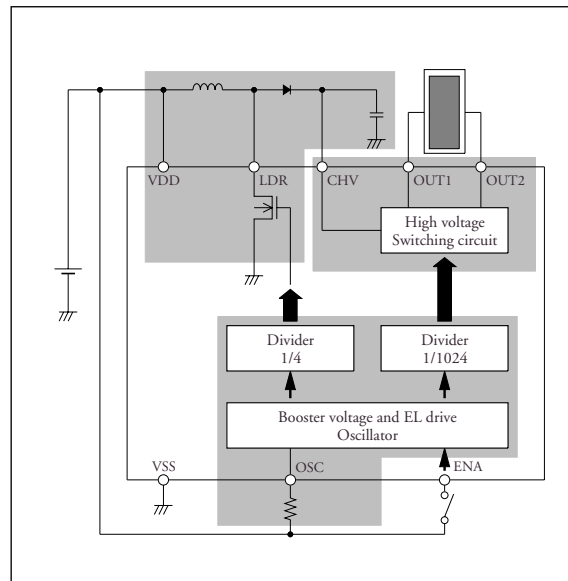

Figure 2. SM8142B

Oscillator

The built-in oscillator circuits require only the connection of an external resistor to form RC oscillator circuits. Changing the value of the external resistor causes the frequency of the oscillator to change. When the resistance is increased, the frequency of oscillation decreases and, conversely, when the resistance is decreased, the frequency of oscillation increases.

The frequency of the oscillator is divided to form two frequency signals, f_{LDR} and f_{OUT} . The f_{LDR} frequency is derived from a 1/4 divider, and f_{OUT} is derived from a 1/1024 divider. The relationship between resistance values and f_{LDR} and f_{OUT} is shown in figures 3 to 6. Note that the measurements shown in the characteristics diagrams were measured using an NPC standard PCB, and that capacitance due to different wiring patterns may have a small effect on these values.

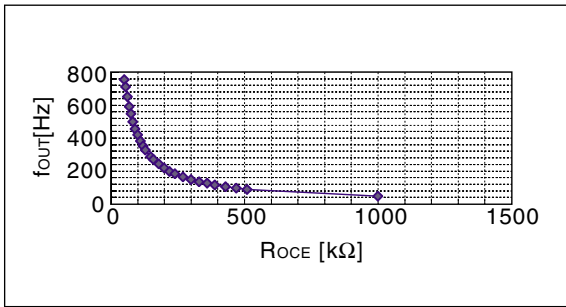

Figure 3. SM8142A $R_{OCE} - f_{OUT}$

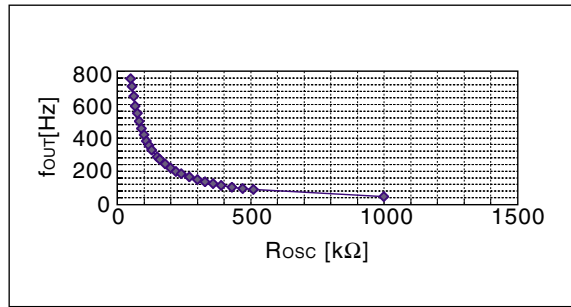

Figure 5. SM8142B $R_{OSC} - f_{OUT}$

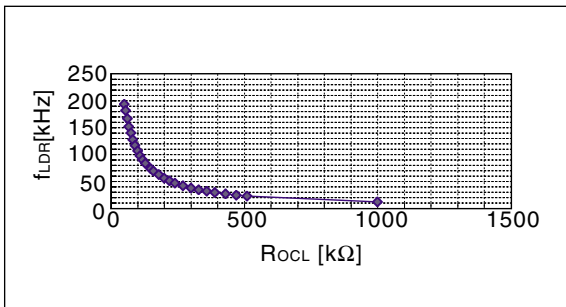

Figure 4. SM8142A $R_{OCL} - f_{LDR}$

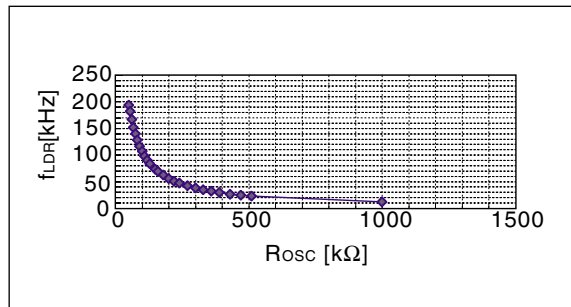

Figure 6. SM8142B $R_{OSC} - f_{LDR}$

Booster

The oscillator frequency is divided by 4 to form the coil drive clock (f_{LDR}), which is used to switch the coil drive transistor to boost the voltage from battery-level voltages up to a maximum of 100V DC. The switching duty ratio is fixed with a cycle of 75% ON and 25% OFF. When the coil drive transistor is ON, the coil current flows through the coil drive transistor, as shown in the following figure.

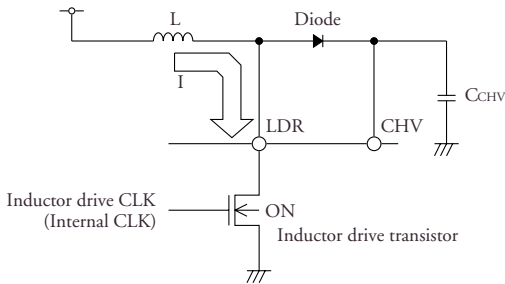

Figure 7. Boost circuit (transistor ON)

The current I [A] is a function of the coil inductance L [H], the voltage across the coil V [V], and the coil drive transistor ON time t_{ON} [sec], given by:

$$I = \left(\frac{V}{L}\right) \times t_{ON} \text{ [A]}$$

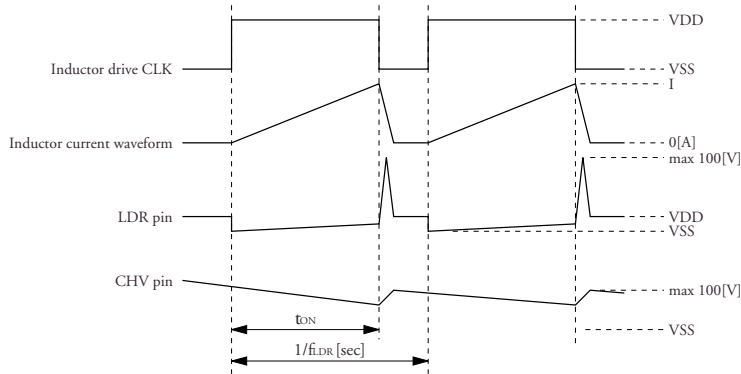

Figure 9. Boost circuit timing

The coil drive clock duty ratio is 75%, and therefore the voltage is applied to the coil for time t_{ON} , given by:

$$t_{ON} = 0.75 \times \frac{1}{f_{LDR}} \text{ [sec]}$$

and the energy stored in the coil (E) is given by:

$$E = \frac{1}{2} \times f_{LDR} \times L \times I^2 \approx 0.28 \times \frac{V^2}{f_{LDR} \times L}$$

and the inductor stores this energy as magnetic energy. When the coil drive transistor is OFF, the current in the coil drive transistor necessarily reduces to zero. However, the inductor current naturally continues to flow and is redirected through the diode and capacitor, which stores the energy as electric energy. At this point, a counter emf appears on pin LDR.

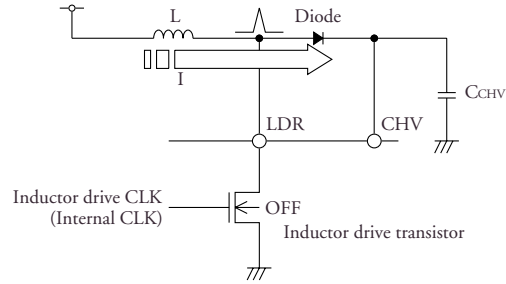

Figure 8. Boost circuit (transistor OFF)

This operation repeats as the transistor is switched ON and OFF, thereby boosting the voltage on pin CHV to stabilize the power consumption in the EL output stage. Note that the rating for the voltage on CHV is 100V maximum, so care should be taken not to exceed this value.

For example, if the frequency is halved, then the ON time for which current flows through the coil is doubled, the current through the coil is also doubled, and the energy stored in the inductance coil is also doubled. Also, if the coil inductance is halved, then the current and energy are doubled. If the voltage is doubled, then the current is doubled and the energy is quadrupled.

The booster energy can be adjusted by controlling the coil inductance drive frequency, the inductance of the coil, and the voltage across the coil to meet the desired application.

Output Stage

The high voltage created in the booster stage is passed to the output stage and two signals OUT1 and OUT2 from a bridge circuit are output at a frequency

f_{OUT} generated by the oscillator. The output frequency can be adjusted using the external resistance values of R_{OCE} (SM8142A) and R_{OSC} (SM8142B).

Output Waveform

Ideally, the SM8142 output waveform for efficient EL illumination is a rectangular-like drive waveform as shown in figure 11. If the EL element oscillates in a particular application, then the output waveform can be slightly smoothed by adjusting an output

resistor R_{OUT} shown in figure 10. The output waveform is smoother for higher values of resistance for R_{OUT} , which will help control noise but at the expense of higher loss.

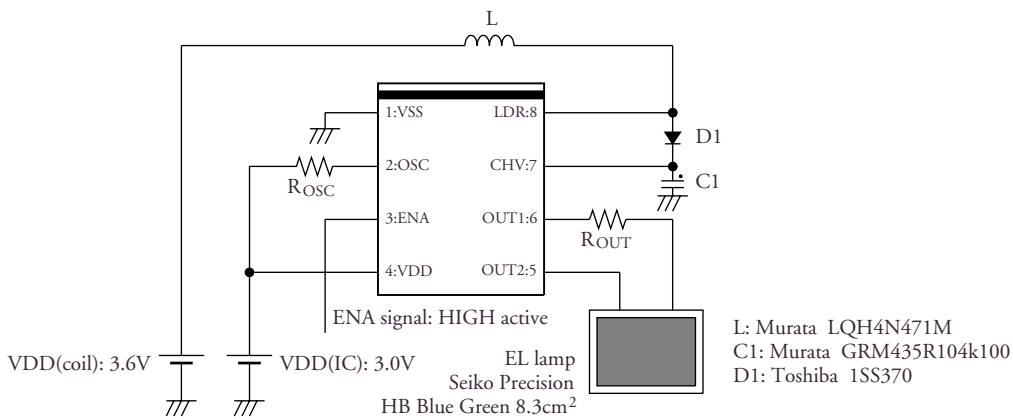

Figure 10. Output waveform adjustment circuit

The effect of R_{OUT} for values of 0, 5.1k Ω , 10k Ω , 20k Ω , and 51k Ω are shown in the following table and figures.

Table 1. Effect of R_{OUT}

R_{OUT} [k Ω]	R_{OSC} [k Ω]	Current consumption [mA]	f_{OUT} [Hz]	V_{OUT} [Vp-p]	Brightness [cd/m ²]	Waveform
0	130	21.2	338	188	31.0	Figure 11
5.1	130	21.2	338	188	29.8	Figure 12
10	130	21.2	338	188	28.9	Figure 13
20	130	21.2	338	187	27.6	Figure 14
51	130	21.2	338	182	24.2	Figure 15

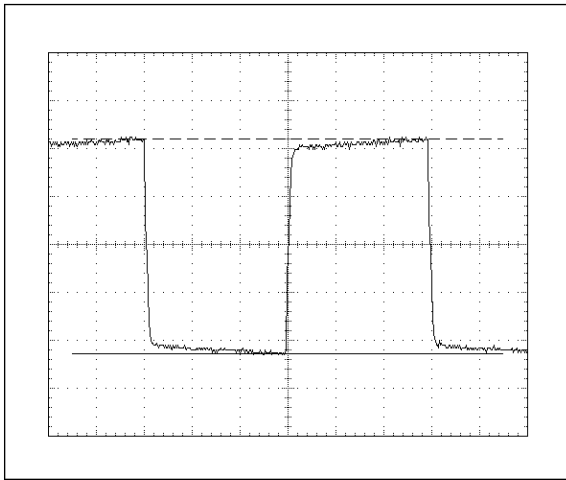

Figure 11. $R_{OUT} = 0$

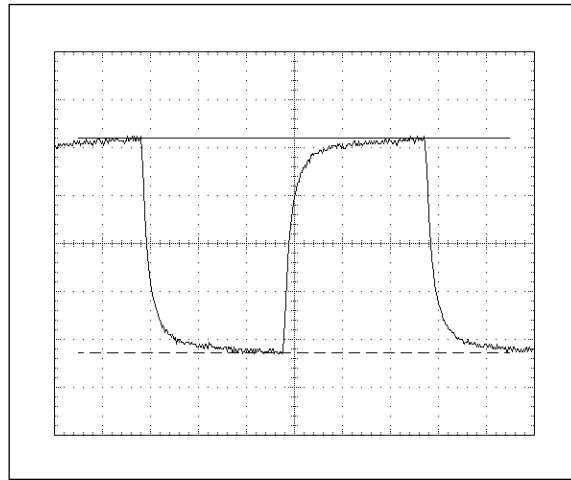

Figure 14. $R_{OUT} = 20k\Omega$

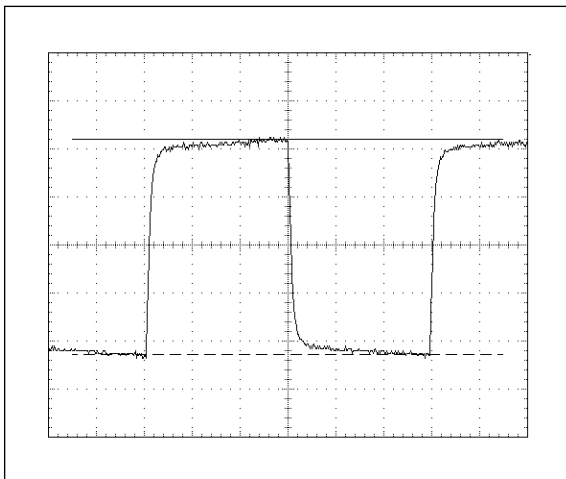

Figure 12. $R_{OUT} = 5.1k\Omega$

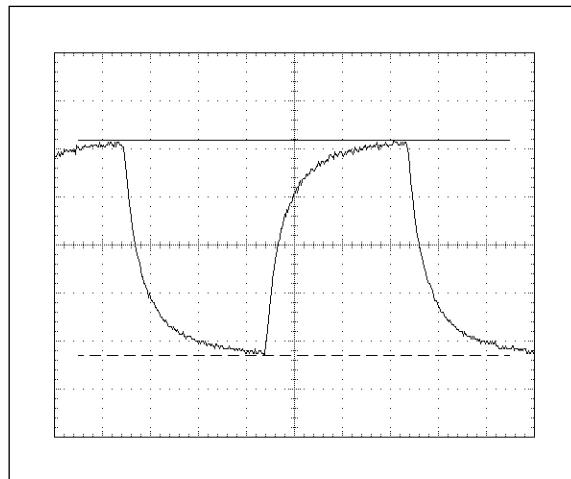

Figure 15. $R_{OUT} = 51k\Omega$

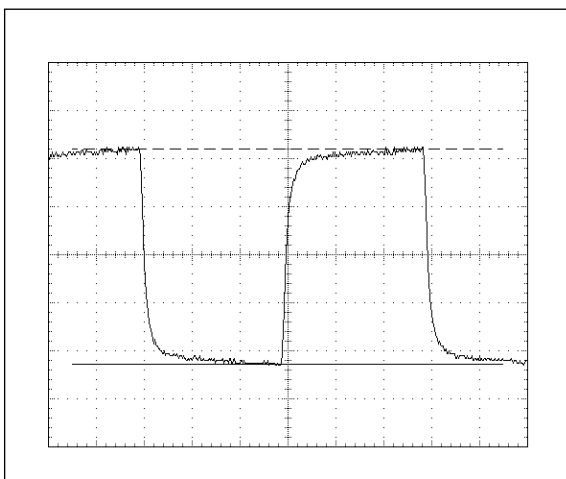

Figure 13. $R_{OUT} = 10k\Omega$

TYPICAL APPLICATION CIRCUIT

SM8142A

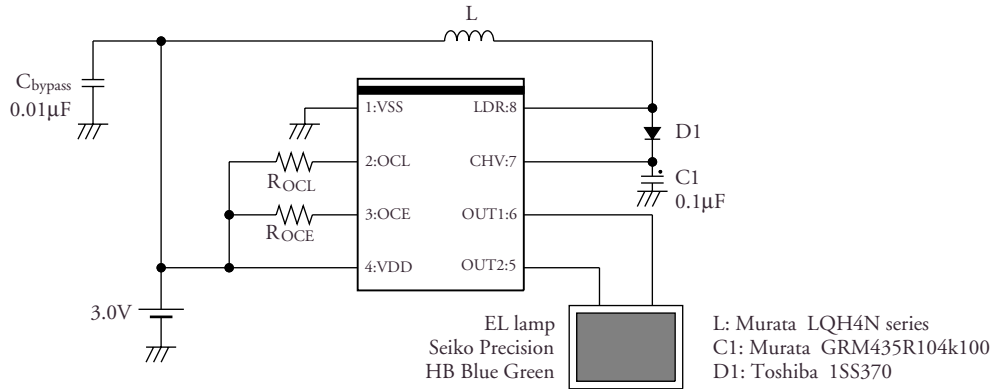

Figure 16. SM8142AD application circuit

The inductance, R_{OCL} , and R_{OCE} can all be adjusted to control the brightness and current consumption

required in a particular application, as summarized in the following table.

Table 2. Typical application values

EL size [cm ²]	Inductance [μH]	R_{OCL} [kΩ]	R_{OCE} [kΩ]	Current consumption [mA]	f_{OUT} [Hz]	V_{OUT} [Vp-p]	Brightness [cd/m ²]
16.7	330	91	180	18.7	248	141	12.4
16.7	470	180	180	25.1	248	148	14.2
16.7	330	180	91	33.5	467	130	17.4
16.7	220	180	180	43.9	248	178	20.2

The characteristics using the circuit in figure 16 for different values of coil inductance, R_{OCL} , and R_{OCE} are shown in figures 17 to 25. Figures 17 to 19 show the relationship between current consumption and R_{OCL} , figures 20 to 22 show the relationship between brightness and R_{OCL} , and figures 23 to 25 show the relationship between brightness and R_{OCE} , provided for reference.

R_{OCL} is the resistor connected to pin OCL. Changing the resistance changes the coil switching frequency, which also changes the coil current and EL brightness. Values should be within the range 40kΩ to 1000kΩ. A high resistance reduces the coil switching frequency and increases the current. Care should be taken not to exceed the rated maximum coil current for high values of R_{OCL} resistance.

R_{OCE} is the resistor connected to pin OCE. Changing the resistance changes the output frequency. Values should be within the range 40kΩ to 1000kΩ. A high resistance reduces the output frequency. Care should be taken not to exceed the maximum rating as the output voltage will be high level if the output frequency is set to low, even if the brightness or the current through the coil is fixed.

Measurement conditions

V_{DD} : 3.0V, EL size: 16.7cm² (refer to figure 16)

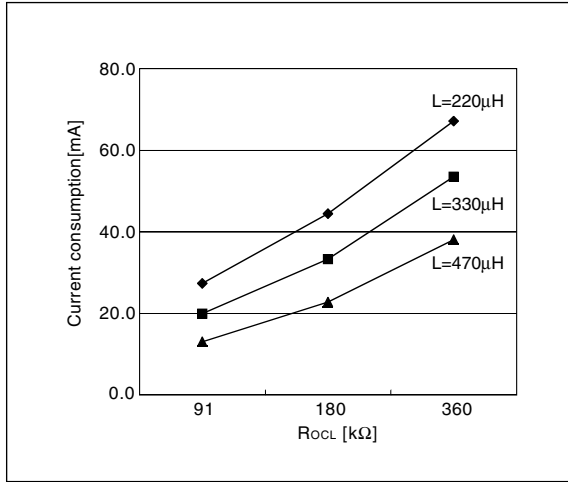

Figure 17. Current consumption – R_{OCL}
($R_{OCE} = 91k\Omega$)

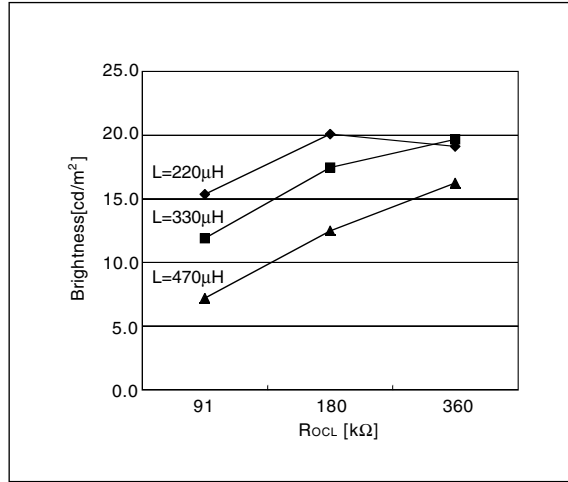

Figure 20. Brightness – R_{OCL}
($R_{OCE} = 91k\Omega$)

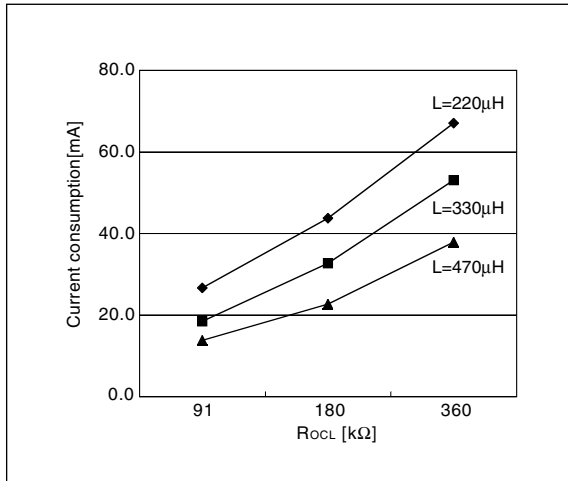

Figure 18. Current consumption – R_{OCL}
($R_{OCE} = 180k\Omega$)

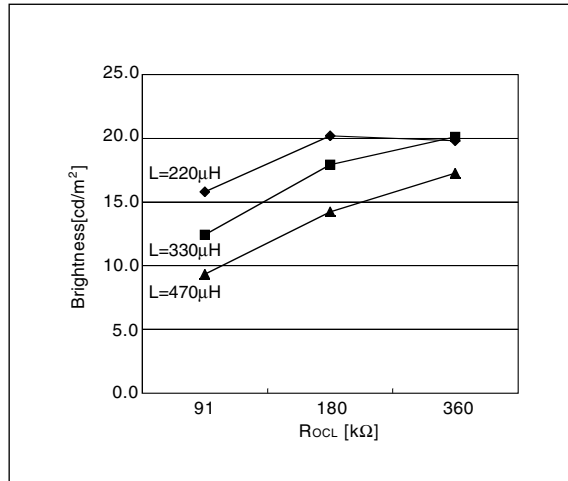

Figure 21. Brightness – R_{OCL}
($R_{OCE} = 180k\Omega$)

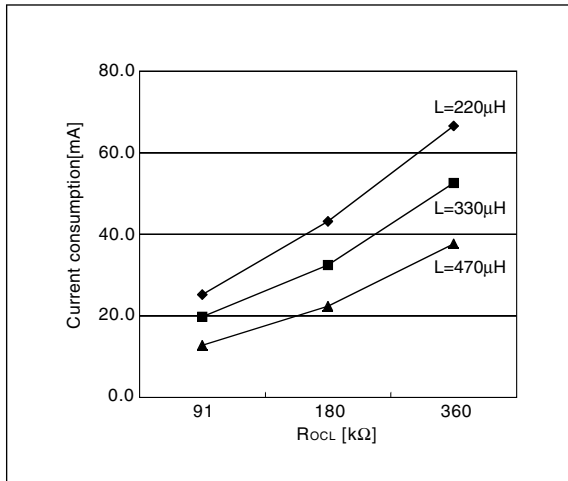

Figure 19. Current consumption – R_{OCL}
($R_{OCE} = 360k\Omega$)

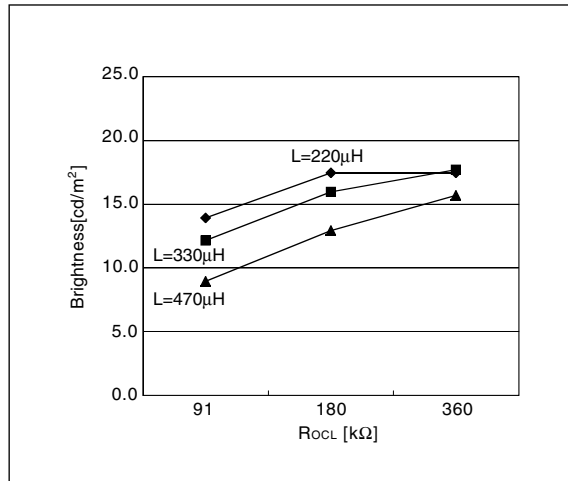

Figure 22. Brightness – R_{OCL}
($R_{OCE} = 360k\Omega$)

V_{DD} : 3.0V, EL size: 16.7cm² (refer to figure 16)

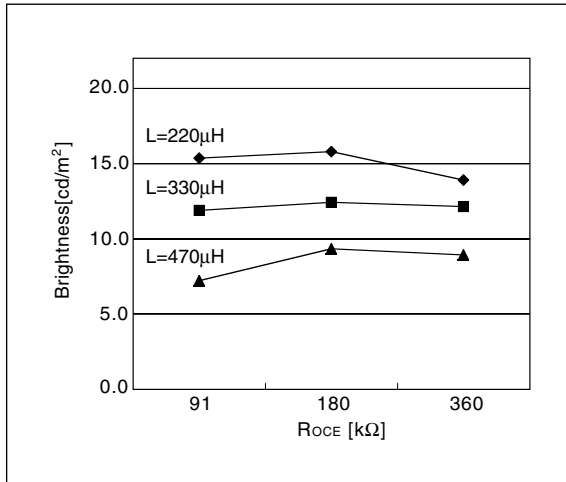

Figure 23. Brightness – ROCE
(ROCL = 91kΩ)

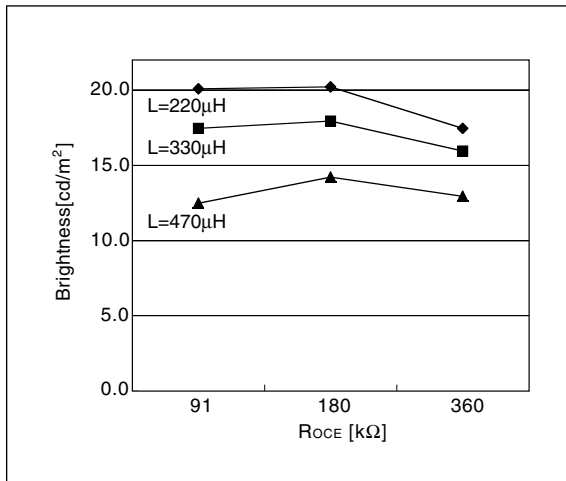

Figure 24. Brightness – ROCE
(ROCL = 180kΩ)

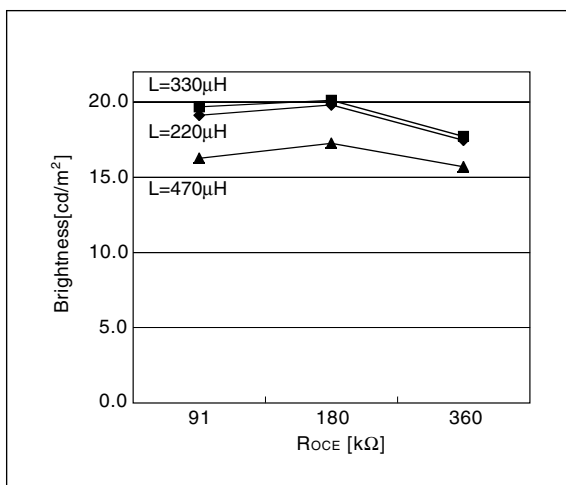

Figure 25. Brightness – ROCE
(ROCL = 360kΩ)

SM8142B

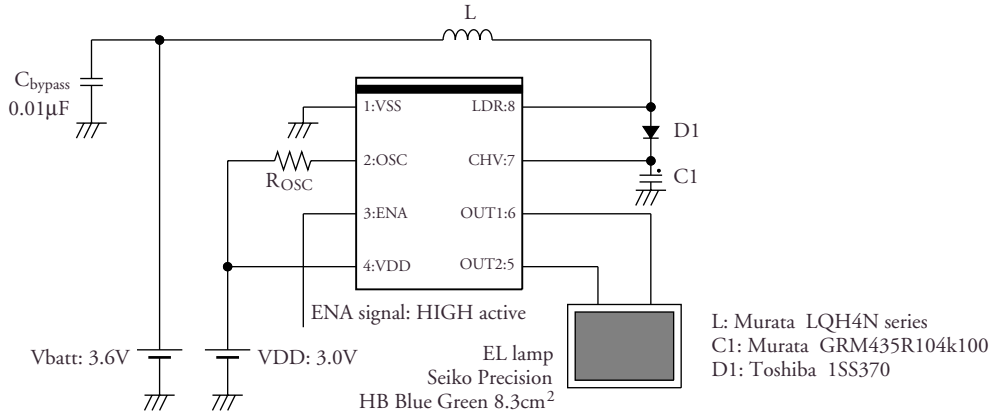

Figure 26. SM8142BD application circuit

The inductance and R_{OSC} can be adjusted to control the brightness and current consumption required in a

particular application, as summarized in the following table.

Table 3. Typical application values

Inductance [μ H]	R_{OSC} [$k\Omega$]	Current consumption [mA]	f_{OUT} [Hz]	V_{OUT} [Vp-p]	Brightness [cd/m^2]
220	91	31.85	472	191	41.5
330	47	13.58	847	112	19.3
330	75	21.55	562	156	32.7
470	56	10.16	725	105	14.9
470	91	16.94	472	153	27.1
470	130	21.02	338	188	31.0

The characteristics using the circuit in figure 26 for different values of coil inductance and R_{OSC} are

shown in figures 27 and 28.

Measurement conditions

V_{DD} : 3.0V, V_{batt} : 3.6V, EL size: 8.3cm² (refer to figure 26)

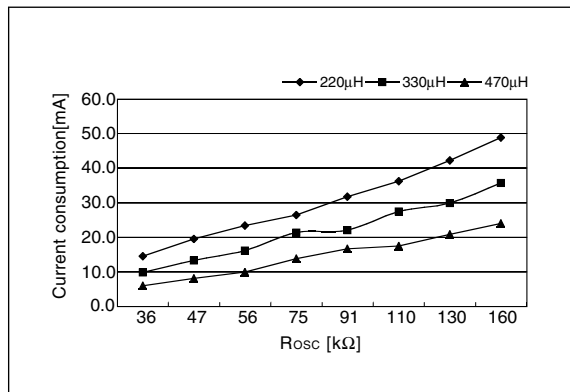

Figure 27. Current consumption – R_{OSC}

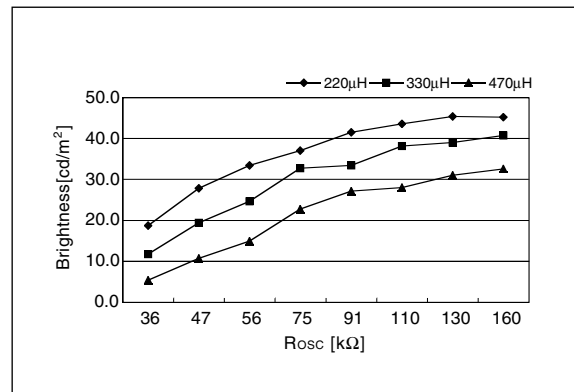

Figure 28. Brightness – R_{OSC}

CONSIDERATIONS SEVERAL TYPES of NOISE

This section considers several types of noise subdivided into audible noise, electromagnetic noise, and

supply wraparound noise. Please refer to datasheet for details.

Audible Noise

Audible noises (or ringing) are mainly caused by the capacitor (C_{CHV}) and the EL panel itself. In addition to the noise from these sources is resonant noise

from the case, PCB and other components (especially the capacitor).

Capacitor (C_{CHV})

Electrical Considerations

The capacitor (C_{CHV}) connection is very susceptible to ringing noise generation due to voltage fluctuations caused by the EL driver. Generally speaking, high-withstand voltage type capacitors generate less ringing noise.

Relatively high ringing output ceramic chip capacitors can be replaced with low ringing output mylar chip capacitors, and further benefit can be obtained if mounting and cost aspects allow.

If the range of devices available for selection is small, electrically reducing the effect of voltage fluctuations will reduce the ringing noise generated. Specifically, R_{CHV} should be inserted (10 to 20k Ω) and R_{OUT} should be increased (50k Ω max).

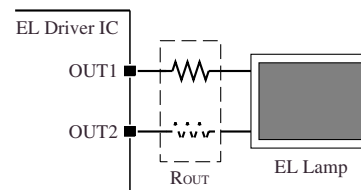
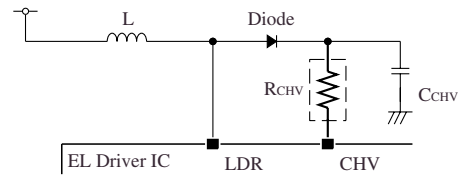

The reduction in C_{CHV} ringing noise is the same in both cases, but making R_{OUT} larger does have an unfavorable result on efficiency. Inserting R_{CHV} , however, is an effective way of reducing only the C_{CHV} ringing noise.

Physical Considerations

The capacitor, which generates the ringing noise, should be mounted as close as possible to the support struts to reduce PCB and case resonant noise. If possible, a more sturdy PCB construction should also be considered.

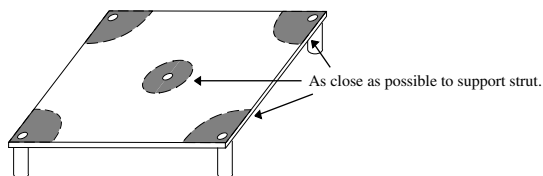

Furthermore, if the chip capacitor is mounted laying on its side, then the contact area with the PCB is minimized which will also help reduce noise.

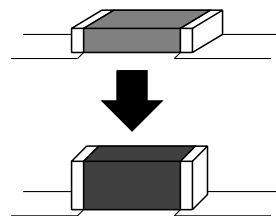

EL Lamp

The EL display has a piezoelectric characteristic, which may generate output noise. There is generally 2 sources that can cause noise, the potential differ-

Electrical Considerations

The EL lamp noise can be reduced by inserting R_{OUT} (50k Ω max) which causes the output waveform to be modified such that the high-frequency components are reduced (see page 4, Output Waveform).

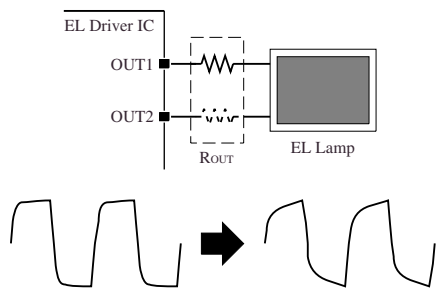

A shielded (3-pin type) EL display is effective in preventing noise between the EL display and other components. Also, the piezoelectric effect can be prevented by avoiding potentials on plane surfaces, such as VDD or ground planes.

Electromagnetic Noise

In addition to the EL lamp acting as an antenna, the driver circuit with its high-voltage booster circuit that uses a coil and capacitor generates radiated

Wiring and Layout

In particular, all circuit wiring between the high-voltage coil, capacitor (C_{CHV}), diode and EL driver LDR pin should be as thick and as short as possible.

EL Lamp

The EL lamp can act as an antenna and emit noise, so, where possible, a shielded EL lamp should be used to reduce the emitted noise.

Components easily affected by induced noise should have their wiring located well away from the EL lamp wiring to prevent induced noise.

Resistor R_{OUT} can be inserted to reduce the high-frequency component of the EL driver waveform.

Coil

The coil is a source of electromagnetic noise, so peripheral components should have high impedance and wiring layout to avoid induced noise. If possible,

ence between the EL display electrodes and the potential difference between the EL display and other components, such as a ground plane.

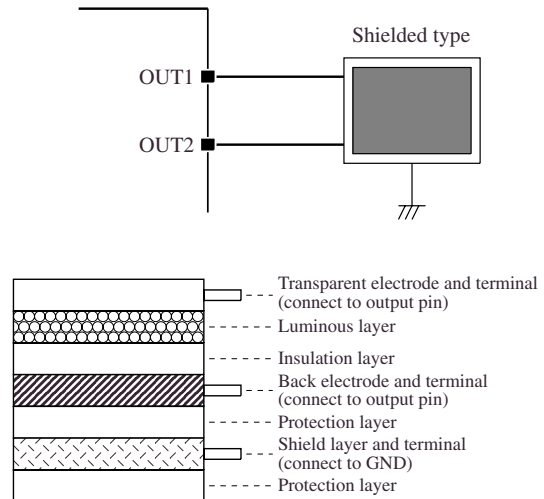

Construction of shielded EL

Physical Considerations

The most effective means of protecting the EL display physically is by using non-woven fabric cloth or PET (plastic) film for absorbing and limiting vibration.

noise caused by the current and capacitive noise induced by the voltage.

Also, the wiring between the outputs (OUT1, OUT2) and EL lamp should be as thick and as short as possible.

Resistors can be inserted at one or both outputs to the EL lamp. If a single resistor is inserted, it can be inserted in the output closest to components affected by induced noise, or in the output furthest from components affected by induced noise. Generally, it is not possible to definitively say which method is the most effective. The best result is obtained by trial-and-error.

the coil should be a closed-magnetic type, such as a toroid.

Supply Wraparound Noise

In the booster circuit, the coil drive transistor switches ON/OFF, generating a sawtooth waveform (see page 3, Figure 9) whose pulse travels from the EL driver LDR pin through to the VSS pin, thereby forming a return path back to the supply. Accordingly, a bypass capacitor (C_{Bypass}) should be connected, adjacent to the coil, between the coil and the EL driver VSS pin to absorb the pulses.

Note that the LDR pin voltage is boosted by the coil and can have amplitudes up to 100V.

The supply system connected to the coil should also be separated as much as possible from the supply lines for other components.

Notice to Application Circuit

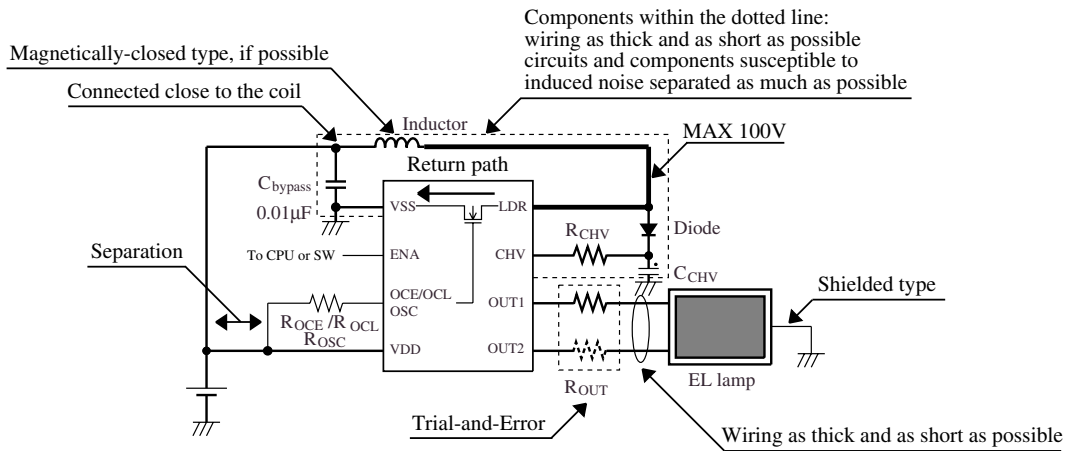

Component	Description	Value
Inductor	Booster coil. The current flowing through the coil is a triangular waveform, and care should be taken so that the peak current does not exceed the maximum current. A coil with low resistance will help reduce loss.	0.15 to 0.68mH
Diode	A fast recovery diode with short reverse recovery time at peak reverse voltages exceeding 100V.	
C_{CHV}	Capacitor rated at $\geq 100V$	0.1 μF (100V)
R_{OCL}	Coil drive frequency control resistor	51 to 1000k Ω
R_{OCE}	EL drive frequency control resistor	51 to 1000k Ω
C_{Bypass}	Supply bypass capacitor (noise cut)	0.01 μF
R_{CHV}	Optional part (necessary if the IC operates at 4V or higher). Reduces the output waveform rise time, and reduces noise.	10 to 20k Ω
R_{OUT}	Optional part (necessary if the EL display is 30cm ² or larger). Reduces noise emitted by the EL element.	$\leq 50k\Omega$

EQUIVALENT CIRCUIT

The EL display driver must not be operated without an output load as this may damage the IC. For testing purposes, including testing during the manufacturing process, where the IC cannot be connected to an EL display, the following equivalent circuit should be used.

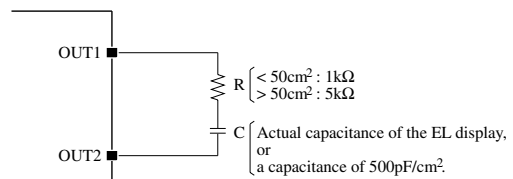

FOOTPRINT

The optimum footprint varies depending on the board material, soldering paste, soldering method, and equipment accuracy, all of which need to be considered to meet design specifications.

(Unit: mm)

Package	b2	L2	e	e1
VSOP-8	0.55	0.95	0.65	5.90
SON-8	0.35	0.45	0.65	2.5

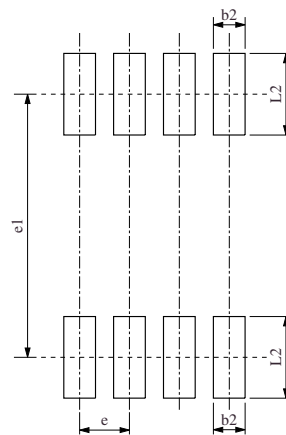

NIPPON PRECISION CIRCUITS INC. reserves the right to make changes to the products described in this document in order to improve the design or performance and to supply the best possible products. Nippon Precision Circuits Inc. assumes no responsibility for the use of any circuits shown in this document, conveys no license under any patent or other rights, and makes no claim that the circuits are free from patent infringement. Applications for any devices shown in this document are for illustration only and Nippon Precision Circuits Inc. makes no claim or warranty that such applications will be suitable for the use specified without further testing or modification. The products described in this document are not intended to use for the apparatus which influence human lives due to the failure or malfunction of the products. Customers are requested to comply with applicable laws and regulations in effect now and hereinafter, including compliance with export controls on the distribution or dissemination of the products. Customers shall not export, directly or indirectly, any products without first obtaining required licenses and approvals from appropriate government agencies.

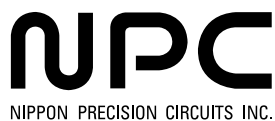

NIPPON PRECISION CIRCUITS INC.

4-3, Fukuzumi 2-chome, Koto-ku,
Tokyo 135-8430, Japan
Telephone: +81-3-3642-6661
Facsimile: +81-3-3642-6698
<http://www.npc.co.jp/>
Email: sales@npc.co.jp

NK9905CE 2001.08